

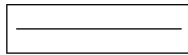

PEPAKURA INDUSTRIES

Cutoff line



Mountain fold line

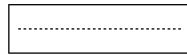

Valley fold line

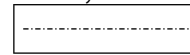

Margin

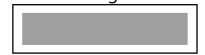

Mane lion original

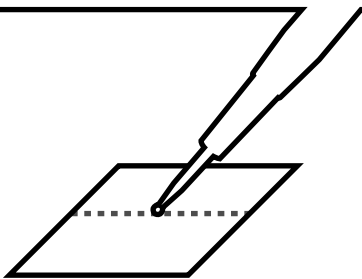

Try to fold the fold line

The better the workmanship at the time of overwhelmingly complete and crease

By the way, the designer has with the fold lines using a cutter .

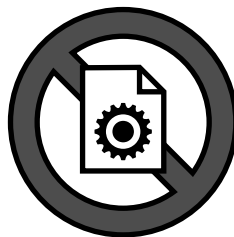

Manual is not a answer

Does not necessarily mean that it is the easiest recipe is to make in the order it is written in the manual

In your own instructions to reference
Also make while thinking the order to assemble

Would surely interesting .

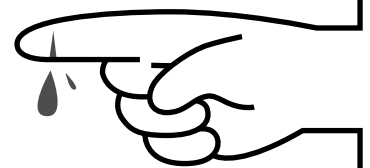

Beware injury

In a paper craft
Is the handling of cutlery to put the best care

When you hurt your hand can not paper craft
So , let's break before tiring

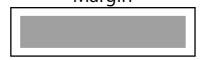
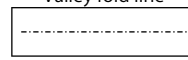
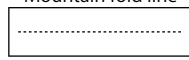
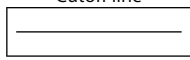

combination

Head

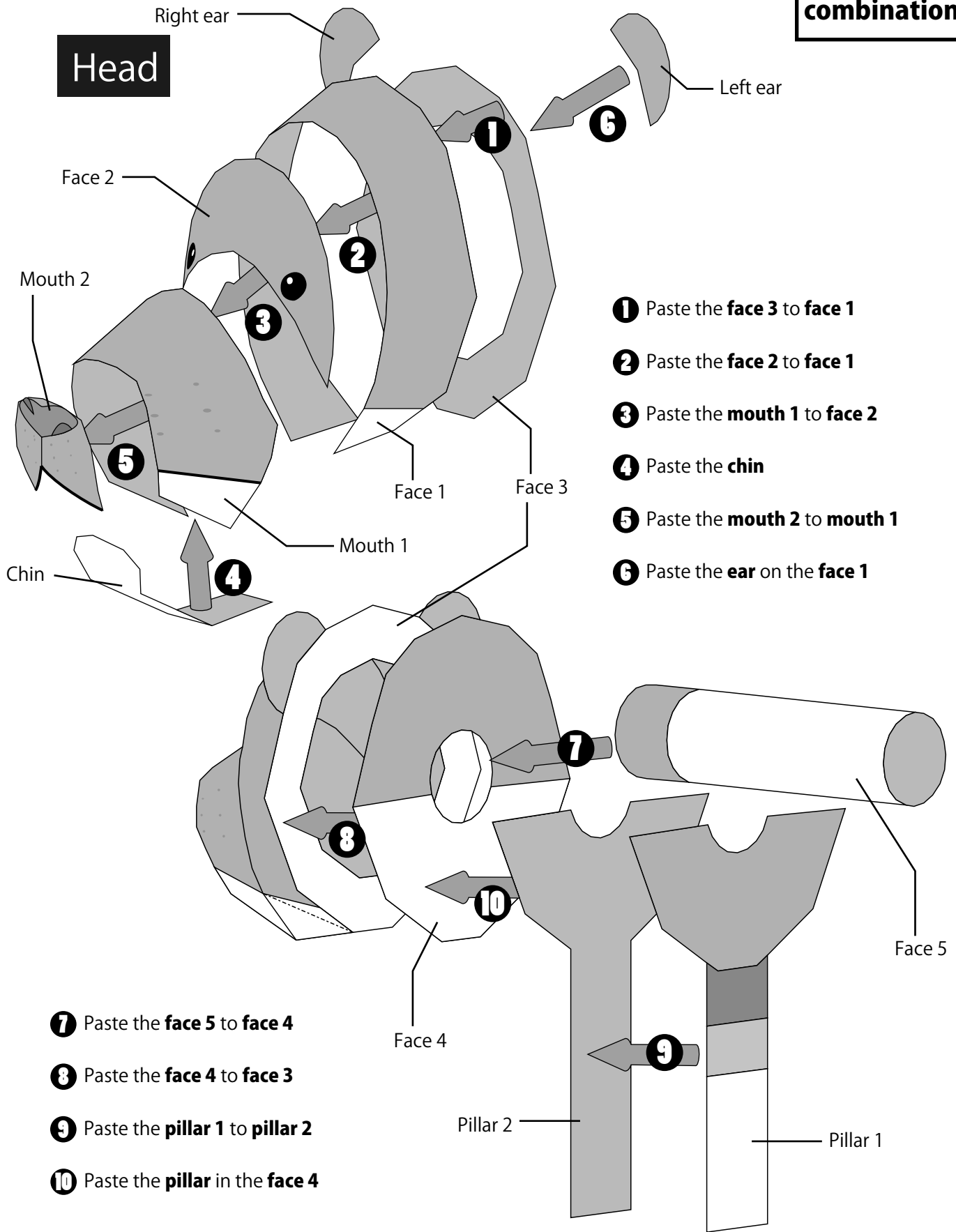

- 1** Paste the **face 3** to **face 1**
- 2** Paste the **face 2** to **face 1**
- 3** Paste the **mouth 1** to **face 2**
- 4** Paste the **chin**
- 5** Paste the **mouth 2** to **mouth 1**
- 6** Paste the **ear** on the **face 1**

- 7** Paste the **face 5** to **face 4**
- 8** Paste the **face 4** to **face 3**
- 9** Paste the **pillar 1** to **pillar 2**
- 10** Paste the **pillar** in the **face 4**

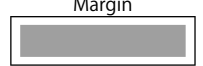
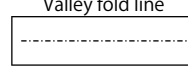
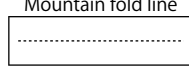
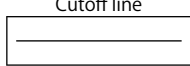

Mane

combination

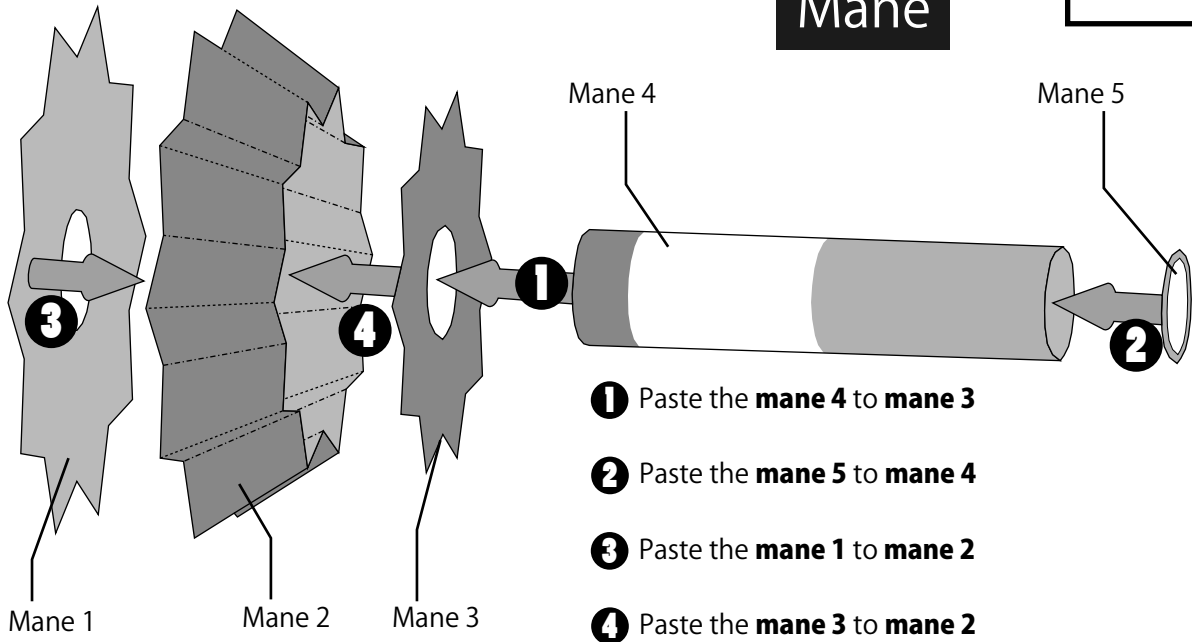

- ❶ Paste the **mane 4** to **mane 3**
- ❷ Paste the **mane 5** to **mane 4**
- ❸ Paste the **mane 1** to **mane 2**
- ❹ Paste the **mane 3** to **mane 2**

combination

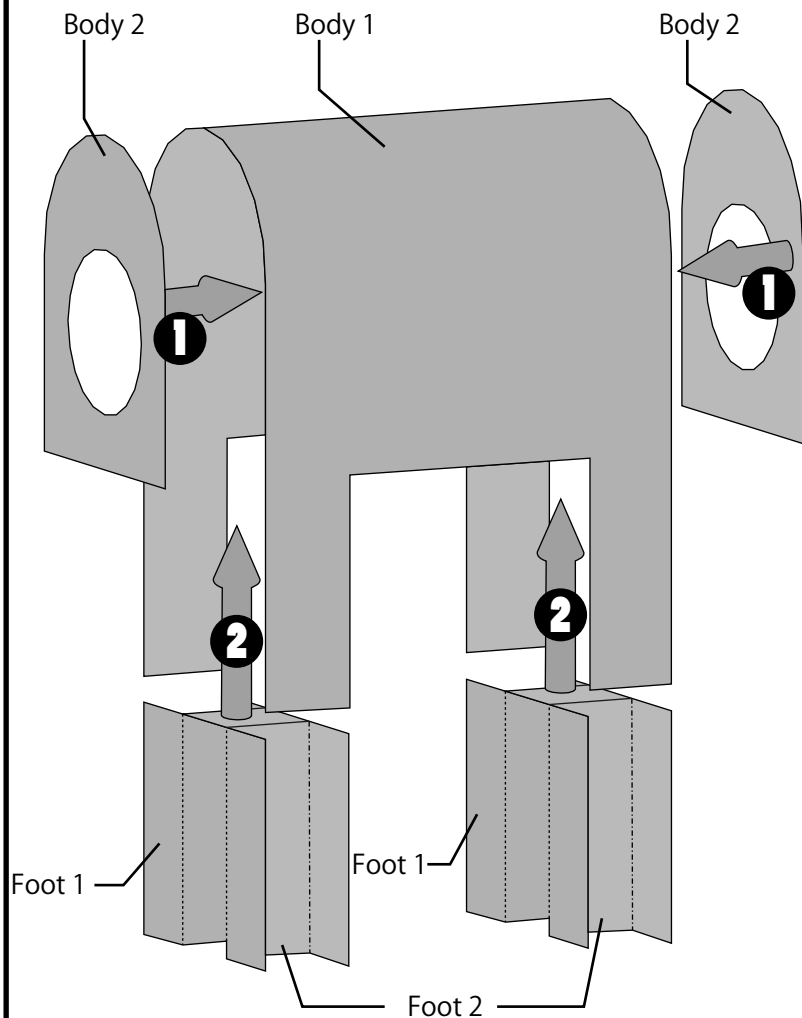

- ❶ Paste the **body 2** to the **body 1**
- ❷ Paste the **leg** to the **body 1**

body

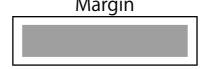
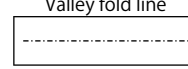
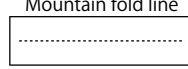
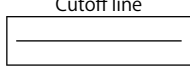

1 Paste the **tail 1** to **tail 2**

2 Plug it into the **mane** the **head**

3 Plug the **mane** to the **body**

4 Paste the **tail** to the **mane**

combination

Lion

1 Paste the **base 1** to **base 2**

2 Paste the **base 3** to the **base 2**

base

combination

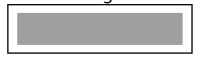
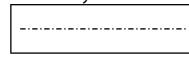
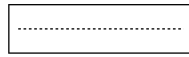
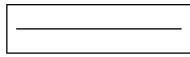

combination

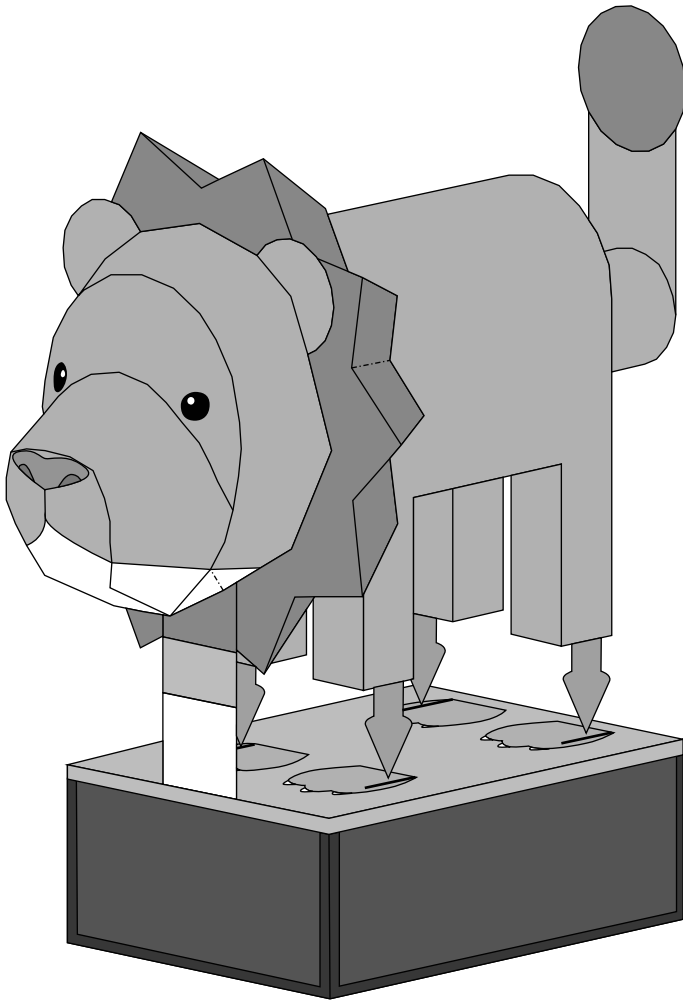

It combines the **Lion** to **base**

Completion

