

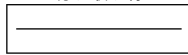

PEPAKURA INDUSTRIES

切り取り線



山折り線

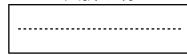

谷折り線

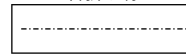

のりしろ



## ダッシュヤー ゲーム

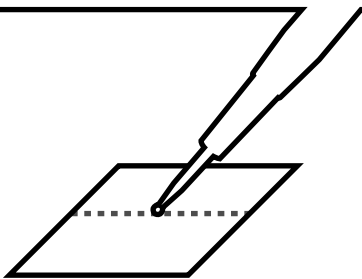

### 折り線に折り目を付けよう

折り目を付けると圧倒的に  
完成時の出来栄がよくなります

ちなみに設計者はカッターを  
使って折り線を付けています。

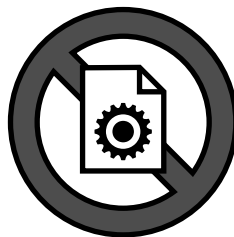

### 説明書が正解ではない

説明書に書いてある順番で作るのが  
一番簡単な作り方だとは限りません

説明書を参考にあなた自身で  
組み立てる順番を考えながら作るのも  
きっと面白いでしょう。

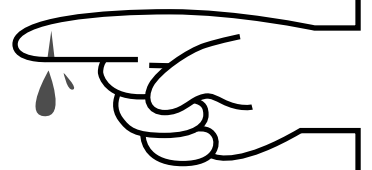

### ケガに気を付けよう

ペーパークラフトをするにあたって  
一番気を付けるのは刃物の扱いです

手をケガしてはペーパークラフトは  
できません、なので  
目が疲れる前に休憩を  
はさむことをお勧めします。

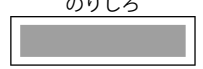
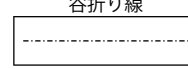
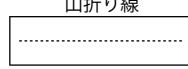
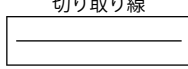

**組み立て**

赤鼻

口1

顔1

手

耳

**組み合わせ**

顔1

顔2 (右)

顔2 (左)

赤鼻

口1

口2

顔

体

右手

左手

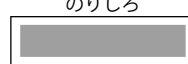
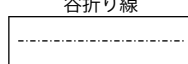
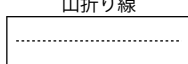
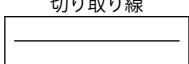

組み立て

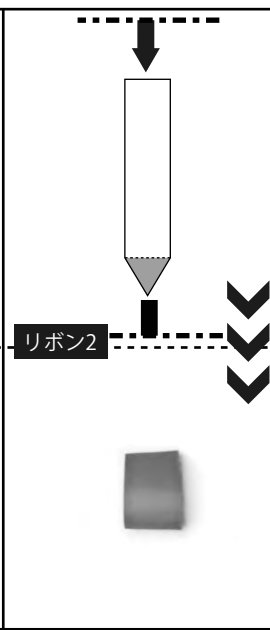
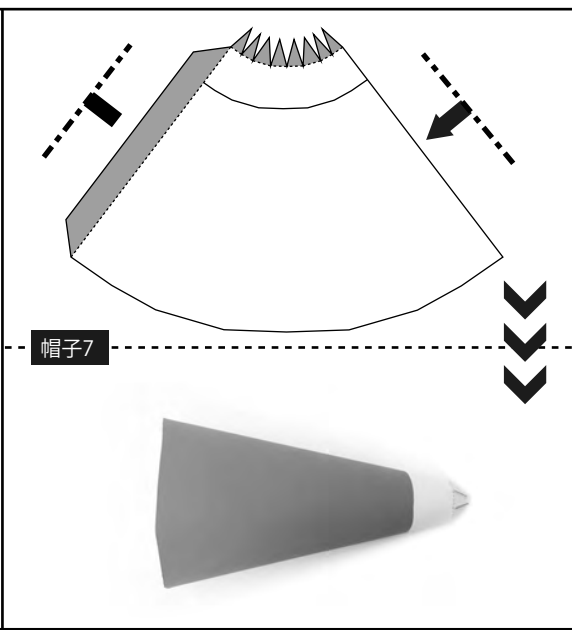
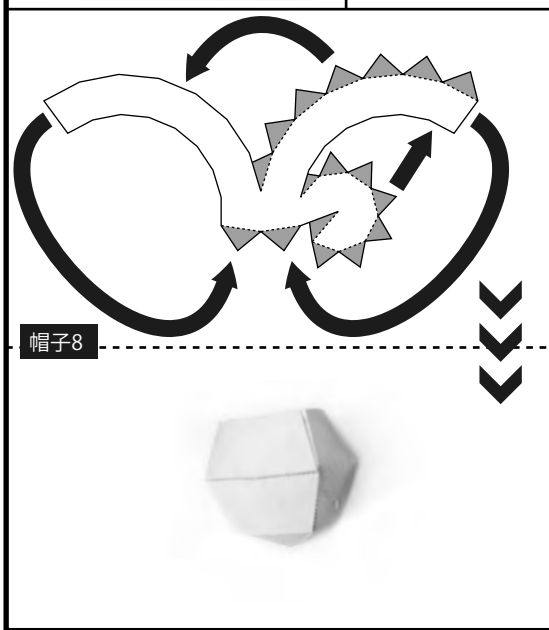
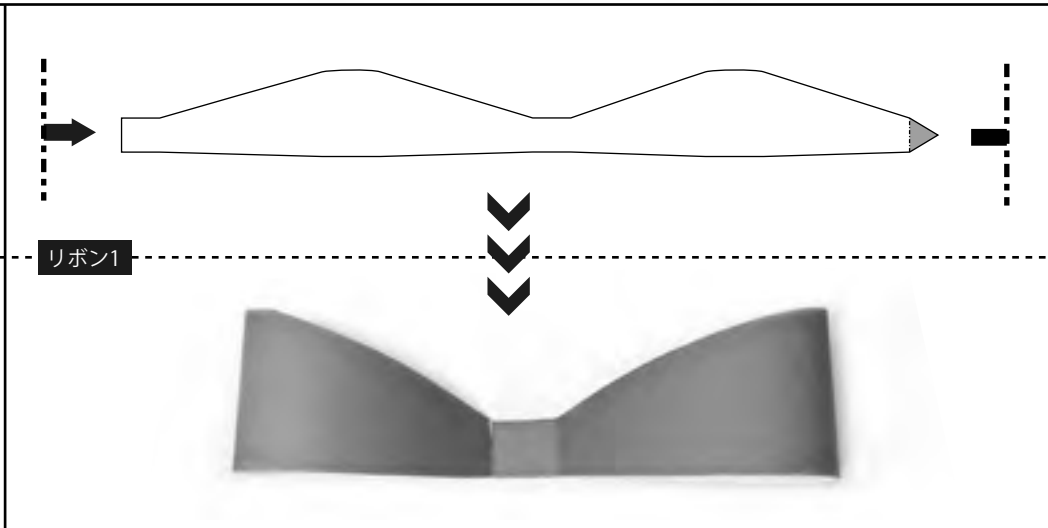
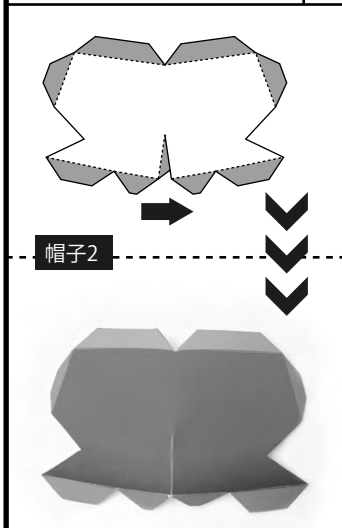
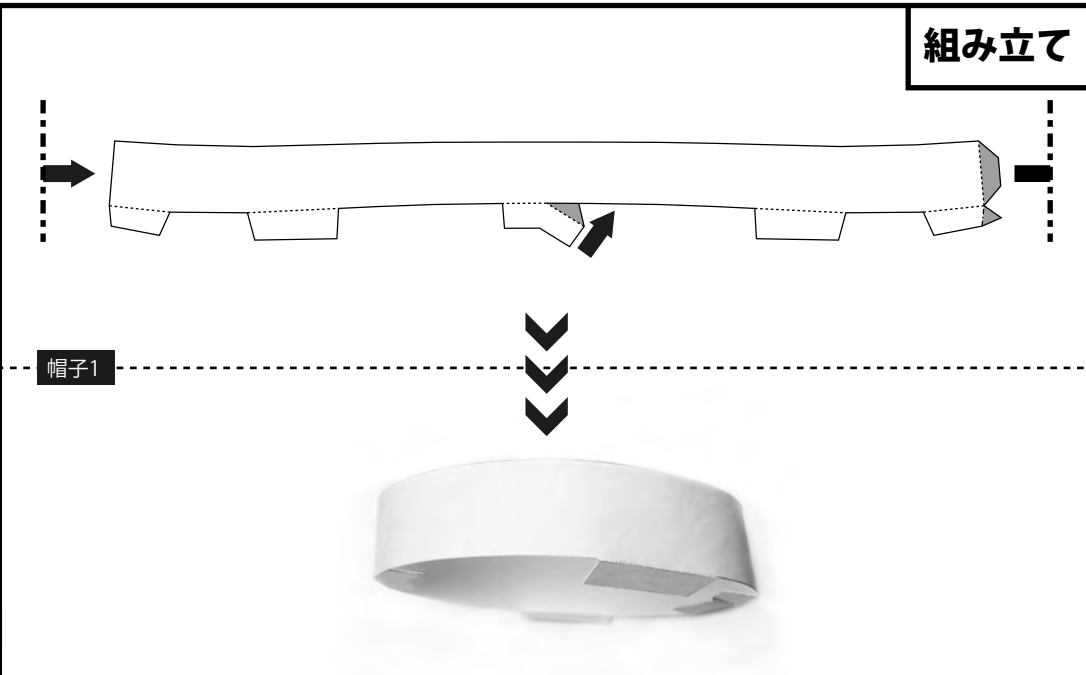
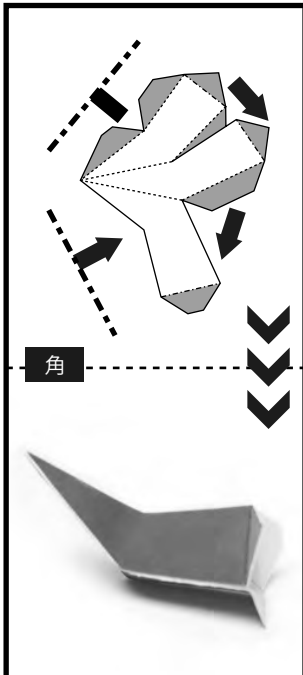

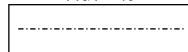
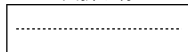
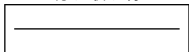

組み合わせ

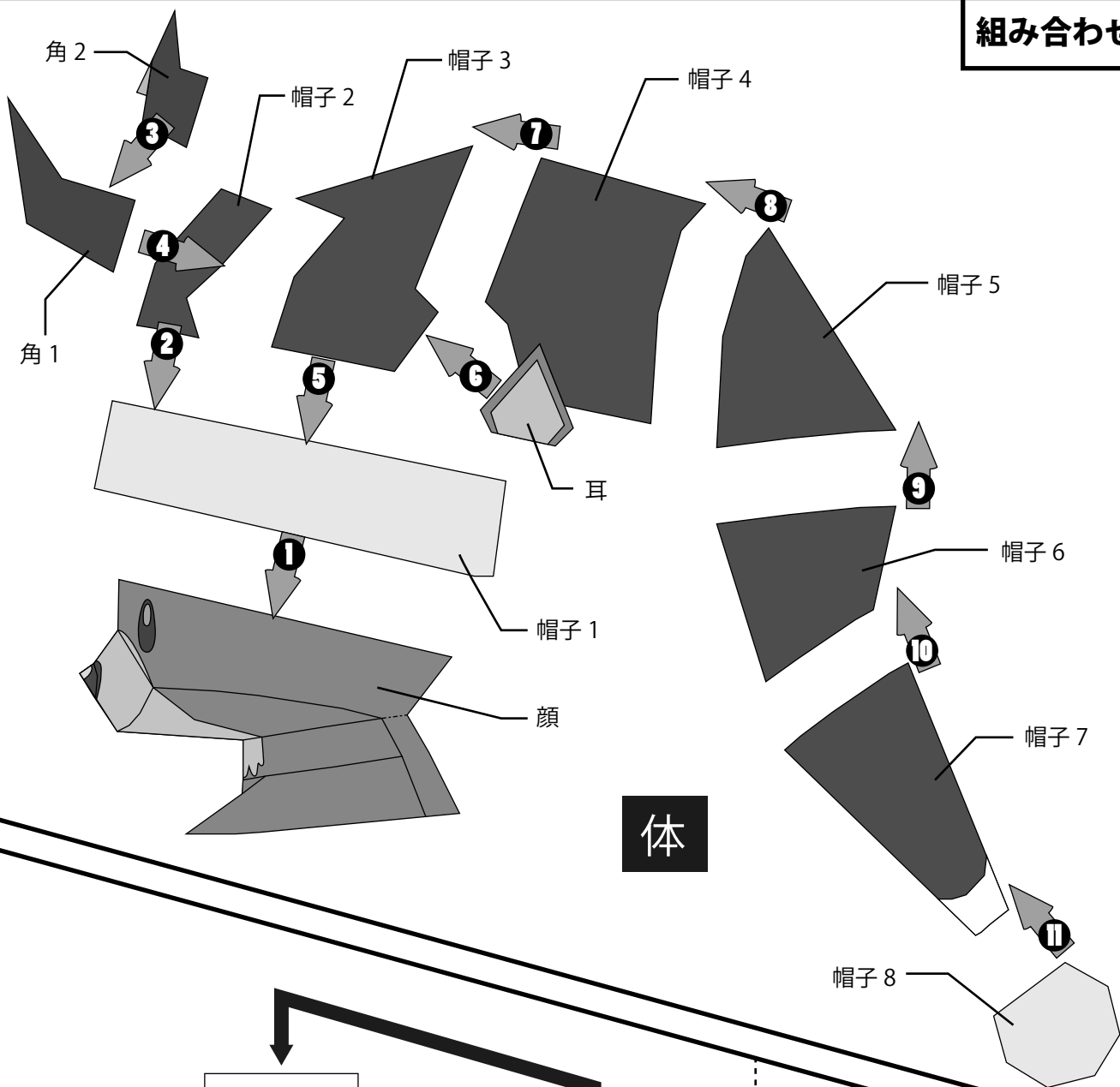

体

ボックス

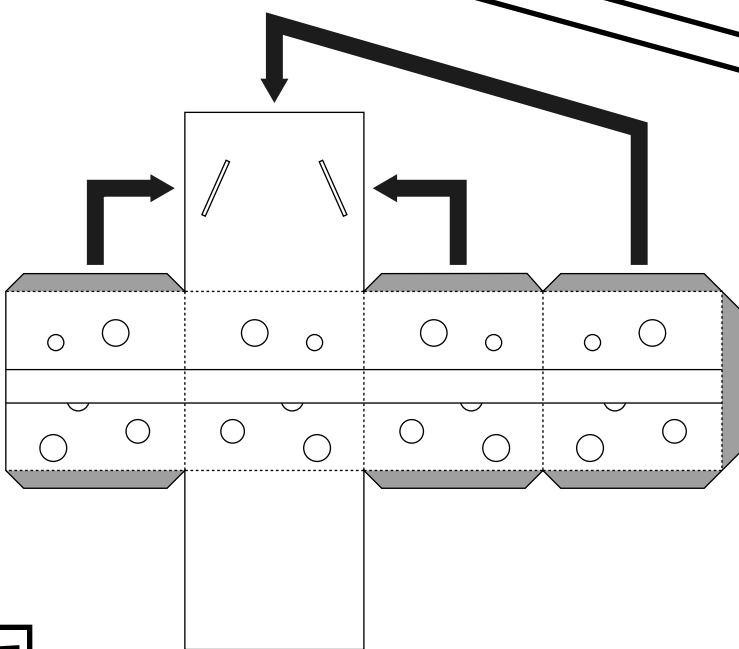

組み立て

## 組み合わせ

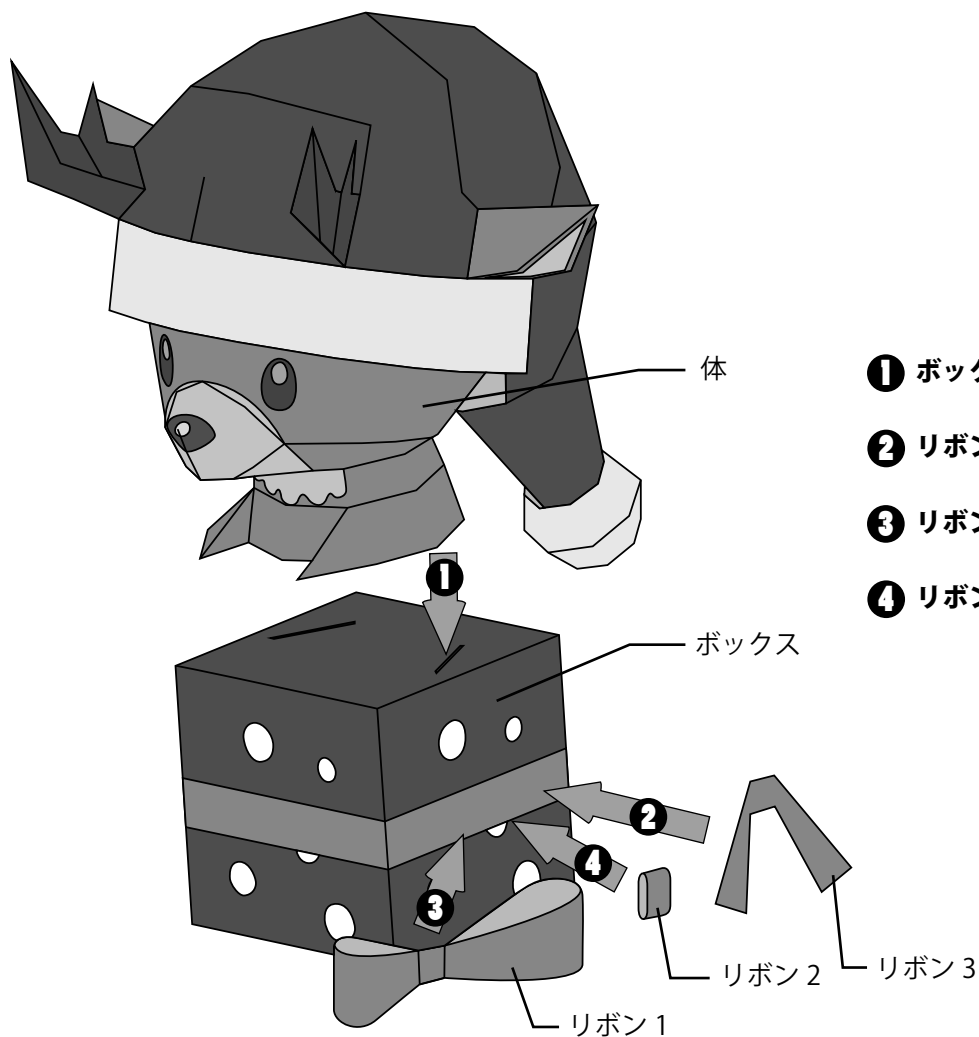

ダッシャー

## 完成

